











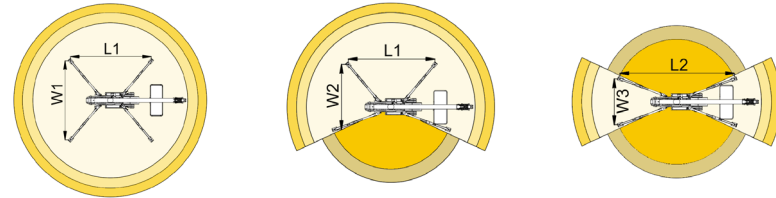
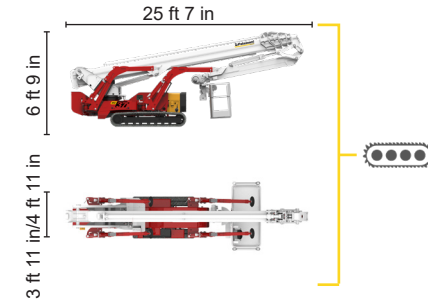
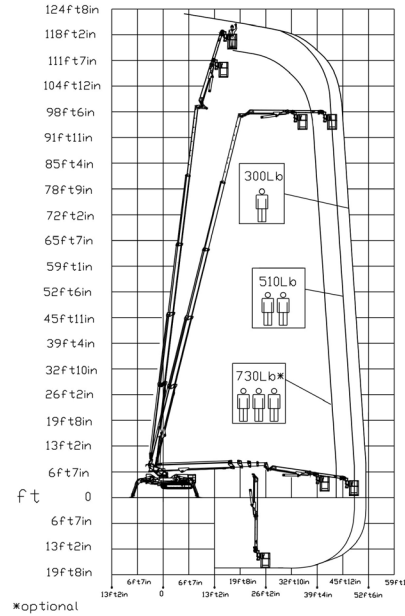
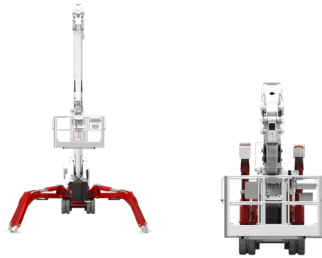













BI-ENERGY

 Diesel
18,2 kW

 Single-phase
Electric motor
110VAC - 3 kW



38 ft 9 in	46 ft 3 in	49 ft 3 in	23 ft 11 in	31 ft 2 in	L1	L2	W1	W2	W3
730 lb*	510 lb	264 lb	730 lb*	264/510 lb	18 ft 2 in	23 ft 6 in	17 ft 3 in	12 ft 7 in	8 ft 9 in

																			
XTJ 121+/C		121 ft 5 in	49 ft 3 in	730 lb*	660°	5 ft 11 in x 2 ft 4 in	90°+80°	8 ft 9 in/17 ft 3 in	23%	36%	1,55 mph	16788 lb	12364 lb	54,7 psf	113,2 psf				

Available power options:

BI-ENERGY (DIESEL+AC)

ECO (AC+BATTERY)

Characteristics and technical data are informative only and subjected to change without notice.

Palazzani Industrie S.p.A.

Via del Pavione, 4 - 25050 - Paderno F.C. (BS) - Italy

Tel. (+39) 0306857073

info@palazzani.it

www.palazzani.it



QUALITY SYSTEM
CERTIFIED BY BUREAU VERITAS
= ISO 9001 =



NC 838 A 22



ECO

Single-phase
Electric motor
110VAC - 16 kW

Lithium iron
phosphate battery
LiFePO4
48V - 420 Ah

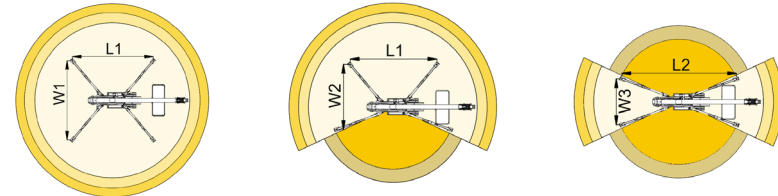
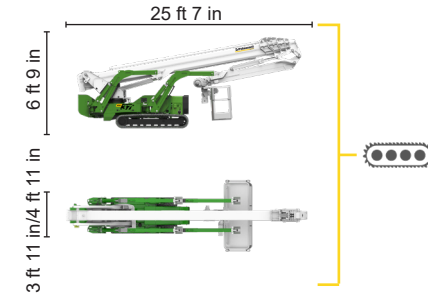
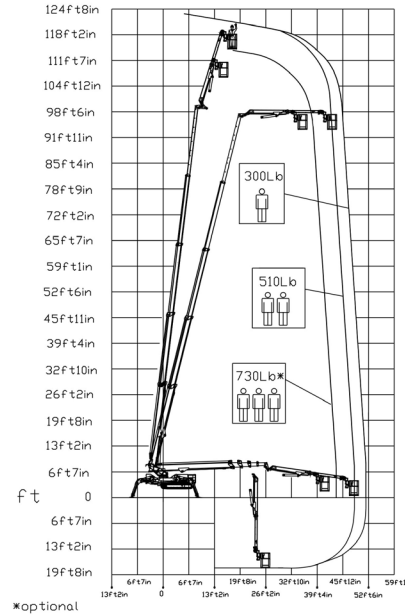
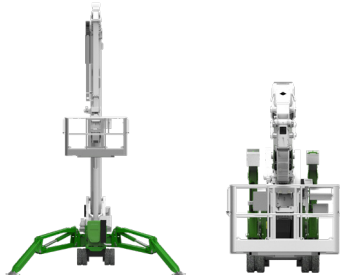

38 ft 9 in	46 ft 3 in	49 ft 3 in	23 ft 11 in	31 ft 2 in	L1	L2	W1	W2	W3
730 lb*	510 lb	264 lb	730 lb*	264/510 lb	18 ft 2 in	23 ft 6 in	17 ft 3 in	12 ft 7 in	8 ft 9 in



XTJ 121+/C		121 ft 5 in	49 ft 3 in	730 lb*	660°	5 ft 11 in x 2 ft 4 in	90°+80°	8 ft 9 in/17 ft 3 in	23%	36%	1,55 mph	16788 lb	12364 lb	54,7 psf	113,2 psf
------------	--	-------------	------------	---------	------	------------------------	---------	----------------------	-----	-----	----------	----------	----------	----------	-----------

Available power options:

BI-ENERGY (DIESEL+AC)

ECO (AC+BATTERY)

Characteristics and technical data are informative only and subjected to change without notice.

Palazzani Industrie S.p.A.

Via del Pavione, 4 - 25050 - Paderno F.C. (BS) - Italy

Tel. (+39) 0306857073

info@palazzani.it

www.palazzani.it



QUALITY SYSTEM
CERTIFIED BY BUREAU VERITAS
= ISO 9001=

NC 840 A 22